







Assembly Instructions

MODEL NO. COY-EC-SD-120-60A



DRWG NO. DRF-55-10-14

V1

HARDWARE LIST

A	 Allen Key M3 - 1PCS M4 - 1PCS	B	 PHM Screw M6 x 16 8 PCS	C	 SET Screw M5 x 8 4 PCS	D	 SET Screw M8 x 20 4 PCS	E	 ADJ-TOP-M6X25 1 PCS	F	 BEAM CAP 2 PCS
----------	---	----------	---	----------	--	----------	---	----------	---	----------	---

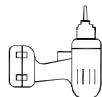
TOOLS REQUIRED

 Hand Drill	 Screwdriver
---	--

STEP1

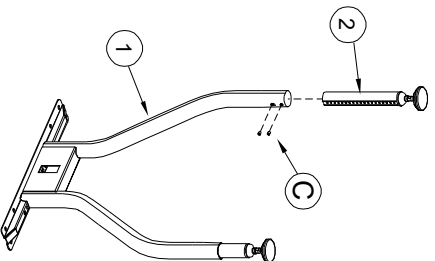

STEP2

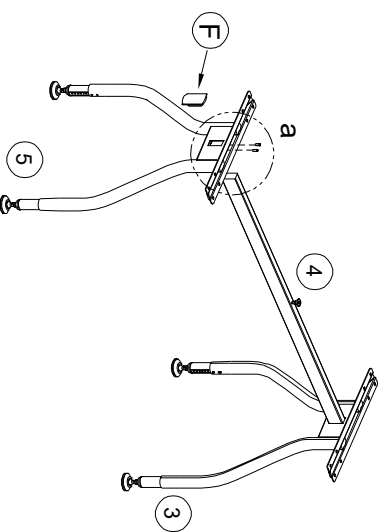

STEP3

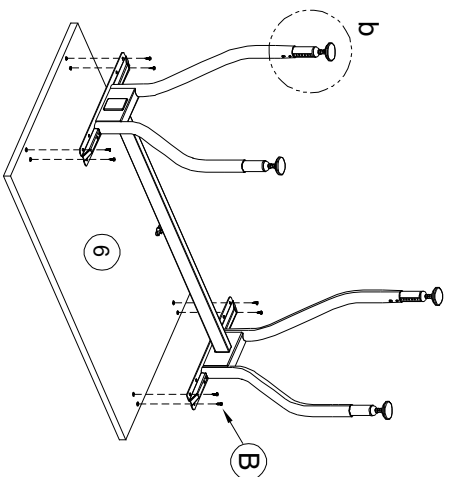

STEP4

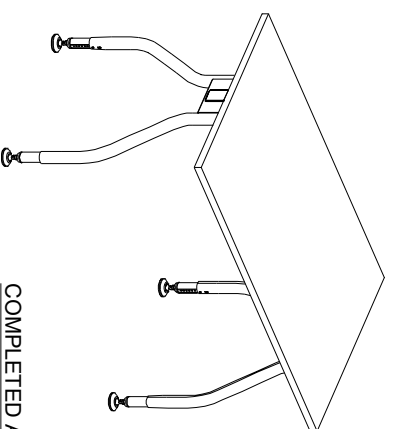

COMPLETED ASSEMBLY

Insert the BEAM and fix it with the two screws on the above

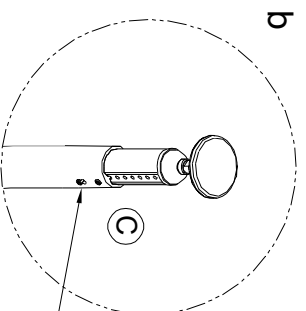
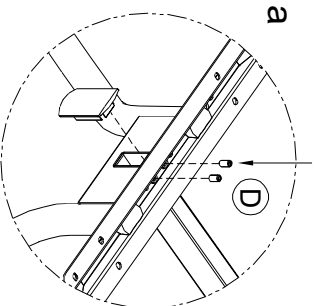

Here you can adjust the height to suit you

IMPORTANT NOTE:

- Place all laminated parts on a clean and smooth surface such as a rug or carpet to avoid the parts from being scratched.
- Check to be sure that you have all parts and hardware.
- Remove all wrapping materials, including staples & packing straps before you start to assemble.
- Keep all hardware parts out of reach of children.
- If the product is not working properly, is missing a part, is damaged, or if you have any questions, please call customer service hotline before returning. To smoothen the process, kindly provide the invoice number, SO number and photo of damaged part or missing pieces to the handler.
- Customer Service Hotline : +6 03 - 3392 6888. For further assembly instructions, please email us at Info@versalink.com

