











Assembly Instructions

MURO CABINET

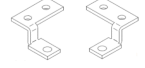

MODEL NO. MRO-EC-3L200A

REV-1

HARDWARE LIST

A  MF-SBOLT-JT-10259 60 PCS	B  MF-CAM-JJ-10107 60 PCS	C  DECO-STC-20-COM 60 PCS	D  DW-WD-M8X40 52 PCS	E  MRO-CTR-LOCK-01 24 PCS	F  MRO-CTR-PLIER-M6 24 PCS
G  S-CB4X16 48 PCS	H  ACC-ADJ-LVL-N2880/ ACC-ADJ-LVL-N2881/ ACC-LVL-N2880-CAP 12 PCS	I  HG-7/8-SCCLP-MP With Euro Screw 16 SETS	J  MRO-END-BRAC-L-4 PCS MRO-END-BRAC-R-4 PCS	K  S-SET-M4X8 8 PCS	L  S-PHS-#4X1/2 16 PCS

TOOLS REQUIRED

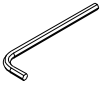
 Hand Drill	 Screwdriver
 Allen Key 4mm	

STEP 1

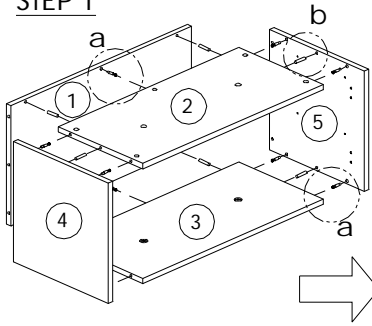

STEP 2

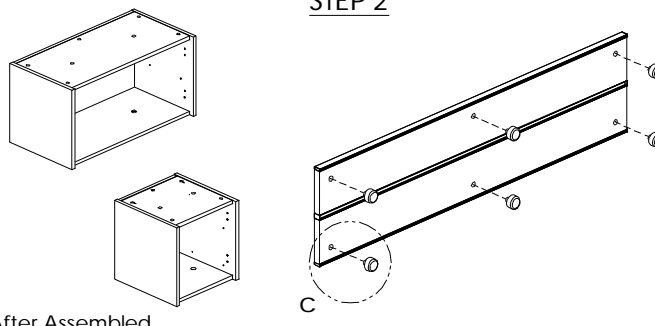

STEP 3

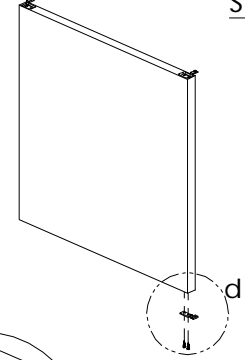

After Assembled

STEP 4

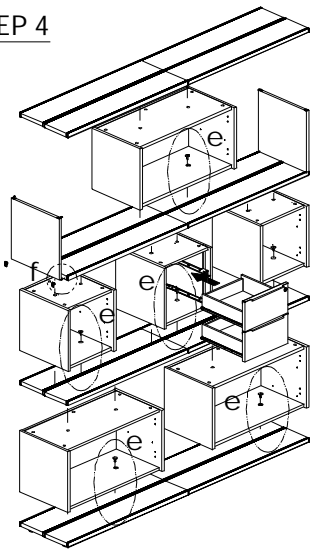

STEP 5

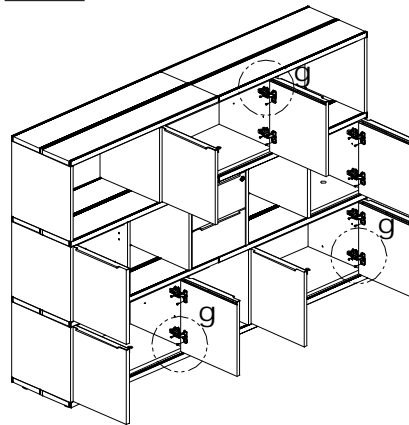

COMPLETED ASSEMBLY

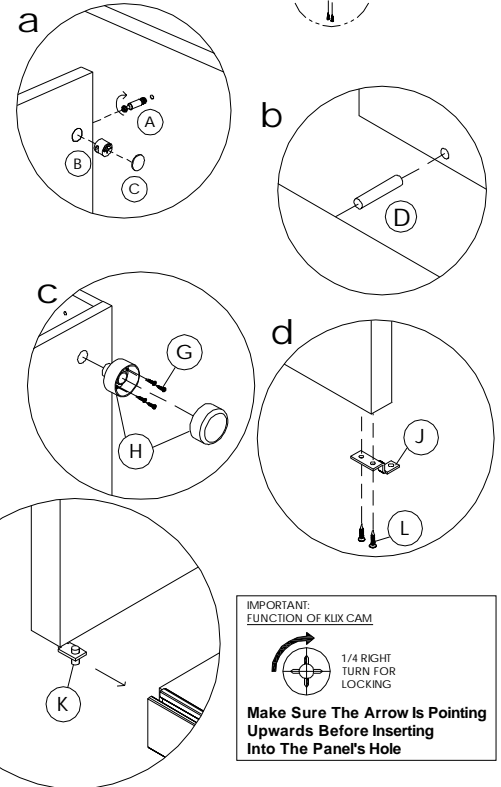
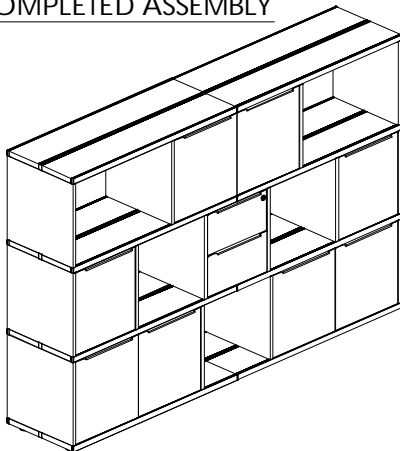

IMPORTANT: FUNCTION OF KLIX CAM

 1/4 RIGHT TURN FOR LOCKING

Make Sure The Arrow Is Pointing Upwards Before Inserting Into The Panel's Hole

To adjust doors

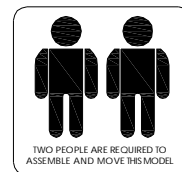
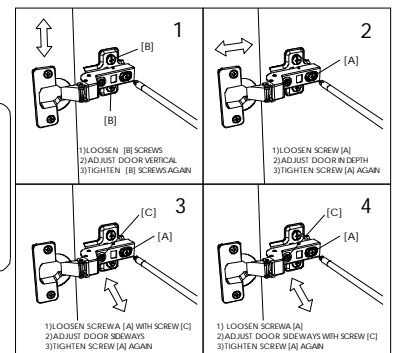

IMPORTANT NOTE:

- 1) Place all laminated parts on a clean and smooth surface such as a rug or carpet to avoid the parts from being scratched.
- 2) Check to be sure that you have all parts and hardware.
- 3) Remove all wrapping materials, including staples & packing straps before you start to assemble.
- 4) Keep all hardware parts out of reach of children.
- 5) If the product is not working properly, is missing a part, is damaged, or if you have any questions, please call customer service hotline before returning. To smoothen the process, kindly provide the invoice number, SO number and photo of damaged part or missing pieces to the handler.
- 6) Customer Service Hotline : +6 03 - 3392 6888. For further assembly instructions, please email us at info@versalink.com