









# Assembly Instructions

## MURO CABINET

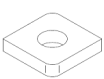

### MODEL NO. MRO-EC-1L160A

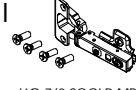
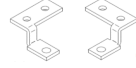
REV-1

**HARDWARE LIST**

<b>A</b>  MF-SBOLT-JT-10259 12 PCS	<b>B</b>  MF-CAM-JJ-10107 12 PCS	<b>C</b>  DECO-STC-20-COM 12 PCS	<b>D</b>  DW-WD-M8X40 12 PCS	<b>E</b>  MRO-CTR-LOCK-01 4 PCS	<b>F</b>  MRO-CTR-PLIER-M6 4 PCS
<b>G</b>  S-CB4X16 24 PCS	<b>H</b>  ACC-ADJ-LVL-N2880/ ACC-ADJ-LVL-N2881/ ACC-LVL-N2880-CAP 6 PCS	<b>I</b>  HG-7/8-SCCLP-MP With Euro Screw 4 SETS	<b>J</b>  MRO-END-BRAC-L-4 PCS MRO-END-BRAC-R-4 PCS	<b>K</b>  S-SET-M4X8 8 PCS	<b>L</b>  S-PHS-#4X1/2 16 PCS

**TOOLS REQUIRED**

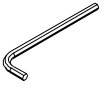
 Hand Drill	 Screwdriver
 Allen Key 4mm	

**STEP 1**

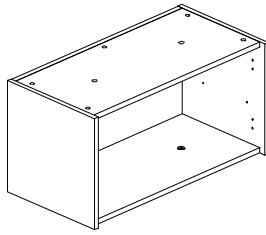
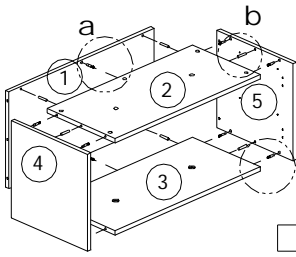

After Assembled

**STEP 2**

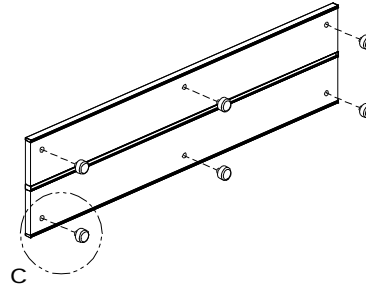

**STEP 3**

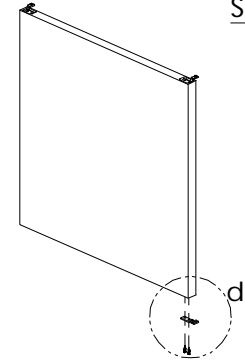

**STEP 4**

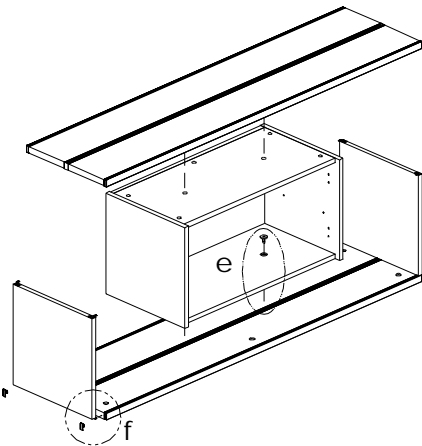

**STEP 5**

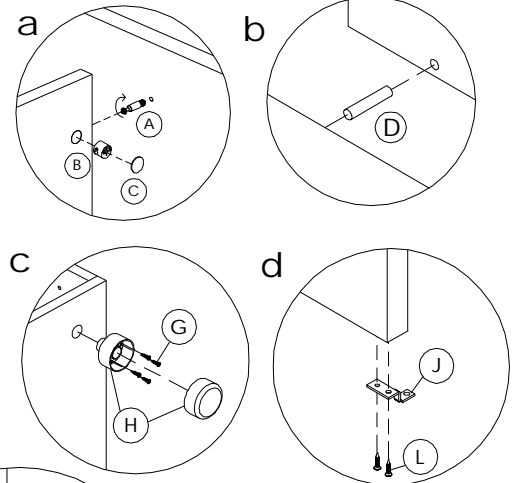
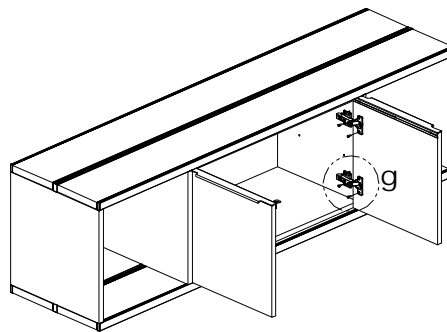

**COMPLETED ASSEMBLY**

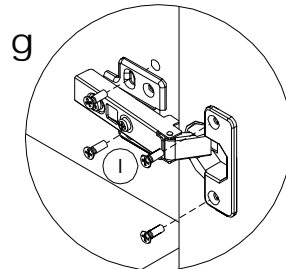
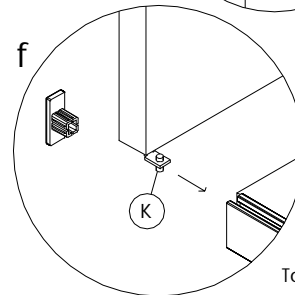
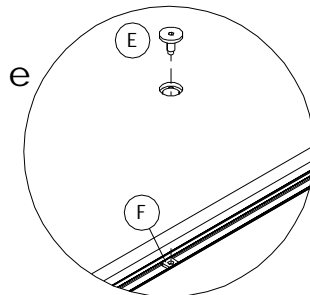
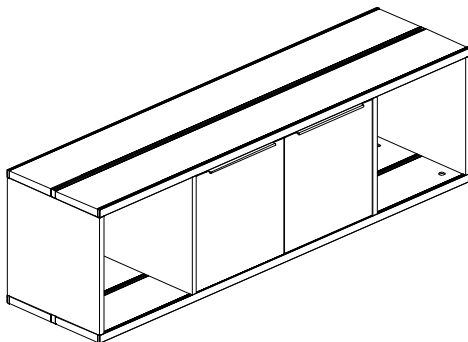

**IMPORTANT: FUNCTION OF KLIX CAM**



1/4 RIGHT TURN FOR LOCKING

**Make Sure The Arrow Is Pointing Upwards Before Inserting Into The Panel's Hole**

**To adjust doors**

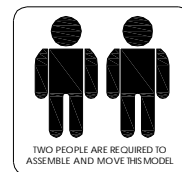
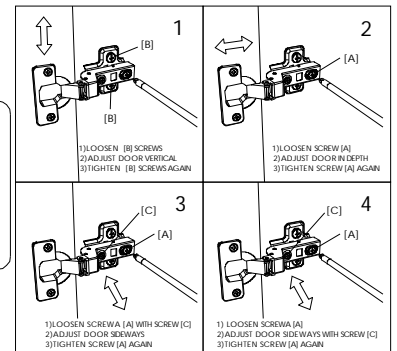

**IMPORTANT NOTE:**

- 1) Place all laminated parts on a clean and smooth surface such as a rug or carpet to avoid the parts from being scratched.
- 2) Check to be sure that you have all parts and hardware.
- 3) Remove all wrapping materials, including staples & packing straps before you start to assemble.
- 4) Keep all hardware parts out of reach of children.
- 5) If the product is not working properly, is missing a part, is damaged, or if you have any questions, please call customer service hotline before returning. To smoothen the process, kindly provide the invoice number, SO number and photo of damaged part or missing pieces to the handler.
- 6) Customer Service Hotline : +6 03 - 3392 6888. For further assembly instructions, please email us at [info@versalink.com](mailto:info@versalink.com)