

Assembly Instructions
BOOKSHELF - CUBO 2 X 2
MODEL NO. CUB-81S1C-50

REV-1

TOOLS REQUIRED



STEP 1

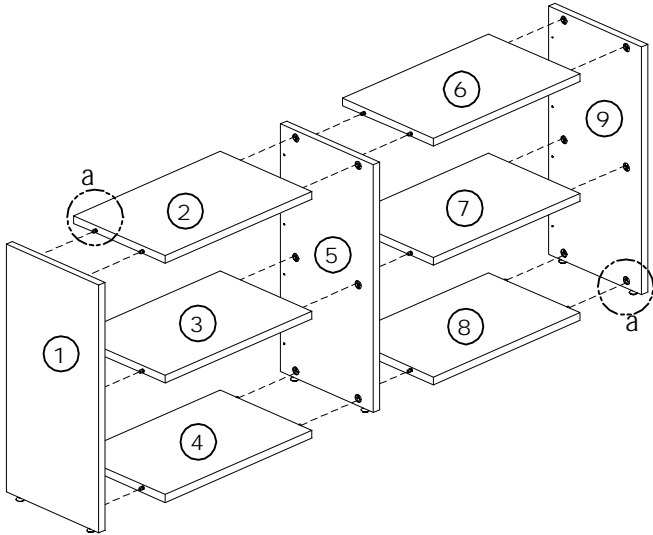

STEP 2

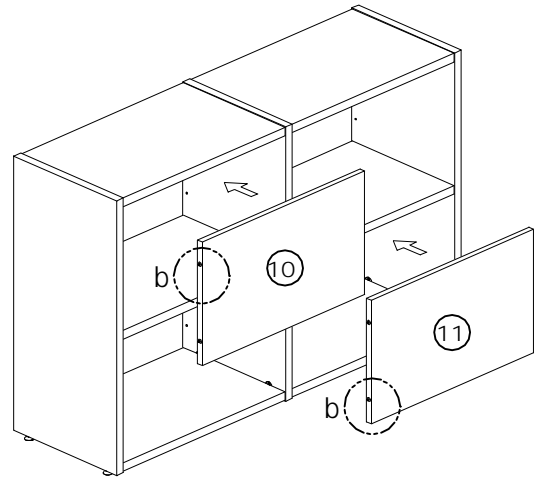

COMPLETED ASSEMBLY

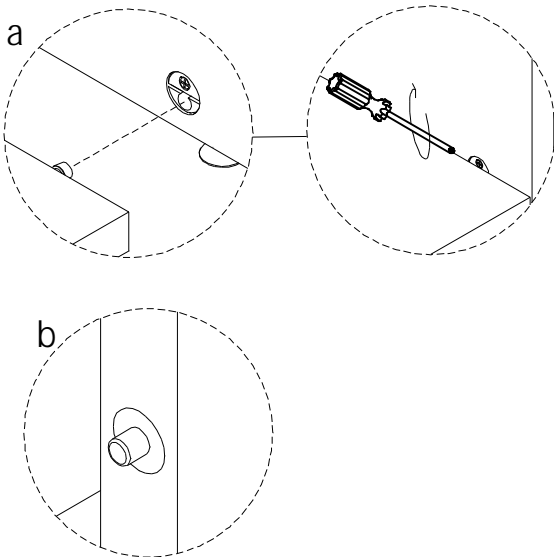
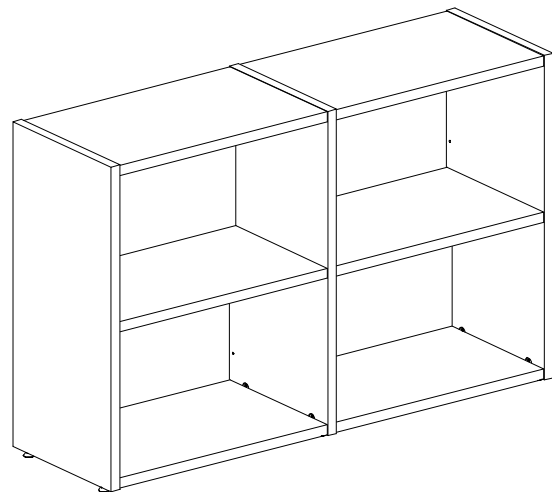

IMPORTANT NOTE:

- 1) Place all laminated parts on a clean and smooth surface such as a rug or carpet to avoid the parts from being scratched.
- 2) Check to be sure that you have all parts and hardware.
- 3) Remove all wrapping materials, including staples & packing straps before you start to assemble.
- 4) Keep all hardware parts out of reach of children.
- 5) If the product is not working properly, is missing a part, is damaged, or if you have any questions, please call customer service hotline before returning. To smoothen the process, kindly provide the invoice number, SO number and photo of damaged part or missing pieces to the handler.
- 6) Customer Service Hotline : +6 03 - 3392 6888. For further assembly instructions, please email us at info@versalink.com

